

DELUXE MASSAGE CHAIR

Damico Libra 3D

Please read the user manual carefully before use.

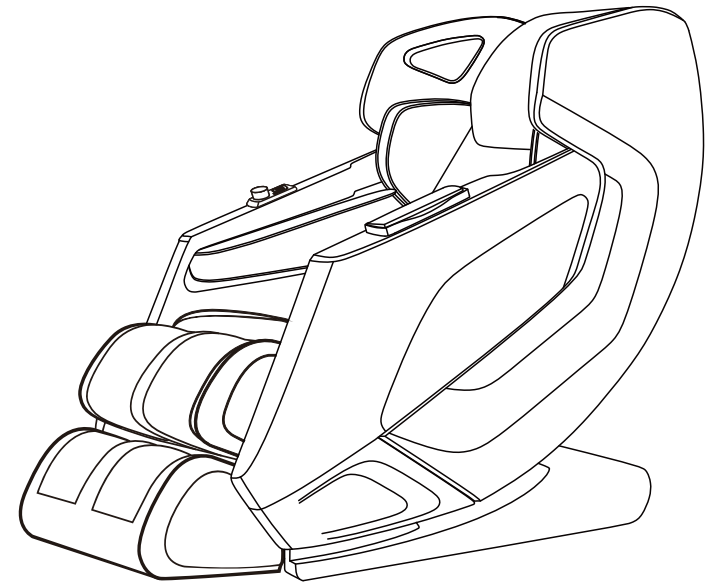

Thank you for choosing our product and your support. In order to understand the directions fully, please read user's manual carefully. And after reading, please keep it for next browsing. We reserve the right of final explanation to the design of product. Dimensions and specifications are subject to change without notice for further improvement.

Contents

Safety -----02-07

Outer Structure-----08

Installation and moving-----09-12

Instructions On Use-----13-15

Panel Icon Instructions-----16-18

Cleaning and Maintenance-----19

Troubleshoot-----20

Specifications -----21

IMPORTANT SAFETY INSTRUCTIONS

This massage chair is intended for household only . When using an electrical appliance, basic precautions should always be followed, including the following: Read all instructions before using this massage chair.

DANGER-To reduce the risk of electric shock:

- 1) Always unplug this appliance from the electrical outlet immediately after using and before cleaning.
- 2) Never use pins or other metallic fasteners with this appliance.
- 3) Carefully examine the covering before each use. Discard the appliance if the covering shows any sign of deterioration, such as checking, blistering, or cracking.
- 4) Keep Dry - Do not operate in a wet or moist condition.

WARNING-To reduce the risk of burns, fire, electric shock, or injury to persons:

- 1) An appliance should never be left unattended when plugged in. Unplug from outlet when not in use, and before putting on or taking off parts.
- 2) Do not operate under blanket or pillow. Excessive heating can occur and cause fire, electric shock, or injury to persons.
- 3) Close supervision is necessary when this appliance is used by, on, or near children, invalids, or disabled persons. Keep children away from extended foot support.
- 4 Use this appliance only for its intended use as described in this manual. Do not use attachments not recommended by the manufacturer.
- 5) Never operate this appliance if it has a damaged cord or plug, if it is not working properly, if it has been dropped or damaged, or dropped into water.
Return the appliance to a service center for examination and repair.
- 6) Do not carry this appliance by supply cord or use cord as a handle.
- 7) Keep the cord away from heated surfaces.
- 8) Never operate the appliance with the air openings blocked. Keep the air openings free of lint, hair, and the like.
- 9) Never drop or insert any object into any opening.

- 10) Do not use outdoors.
- 11) Do not operate where aerosol (spray) products are being used or where oxygen is being administered.
- 12) To disconnect, turn all controls to the off position, then remove plug from outlet.
- 13) Temperatures sufficiently high to cause burns may occur regardless of the control setting. Do not use on an infant or invalid or on a sleeping or unconscious person. Do not use on insensitive skin or on a person with poor blood circulation. Check the skin in contact with the heated area of the appliance frequently to reduce the risk of blistering.
- 14) Do Not Crush - Avoid sharp folds.
- 15) Do not use massager in close proximity to loose clothing or jewelry.
- 16) Keep long hair away from massager while in use.
- 17) Connect this appliance to a properly grounded outlet only. See Grounding Instructions.
- 18) The apparatus shall not be exposed to dripping or splashing and that no objects filled with liquids, such as vases, shall be placed on the apparatus.
- 19) An apparatus with CLASS I construction shall be connected to a MAINS socket outlet with a protective earthing connection
- 20) The appliance coupler is used as the disconnect device, the disconnect device shall remain readily operatable.
- 21) This appliance is not intended for use by persons (including children) with reduced physical, sensory or mental capabilities, or lack of experience and knowledge, unless they have been given supervision or instruction concerning use of the appliance by a person responsible for their safety.
- 22) If it is not in use for a long time or after use, please turn off the power and pull out the power plug.
- 23) Do not damage, break, over-bend, compress, tighten, wind, rotate or knot the power cord.

SAVE THESE INSTRUCTIONS

This massage chair is intended for household use only.

● Usage Environment

- Do not use the massage chair in an excessively humid or dusty environment as this may result in malfunction or electric shock.
- Do not use the massage chair in a room with a temperature of 104°F or higher.
- Do not expose the massage chair to heaters, stoves or direct sunlight.
- Place and use the massage chair on an even, non-slip floor.
- The massage chair is designed for home use and not for commercial purposes.

Caution

- The massage chair is to be used indoors only.
- If you use the massage chair in a cold room, do not increase the room temperature abruptly. It is recommended that you increase the temperature gradually to a normal level.
- If the massage chair is stored in a cold place and is being brought into a warm environment, it is advisable to wait one hour before use. This is because its performance may not be at optimum level, as there may be water droplets on the mechanical parts due to condensation. Using the massage chair under such conditions may result in malfunction.

IMPORTANT SAFETY INSTRUCTIONS

● Safety Precautions

- To ensure safe and correct use of the massage chair, do not operate it without reading this operation manual carefully.
- Do not use the massage chair when the upholstery or seat is removed. This may cause injury or malfunction.
- Do not use the massage chair in combination with other therapeutic equipment or electric blanket, etc., as this may result in ineffectiveness or injury.
- Do not use the massage chair an hour before or after eating as this may have adverse effects on the user.
- Do not allow children or pets to play around the massage chair, e.g., behind the backrest, under the seat or leg rest of the massage chair. This may result in injury.

- Do not rest or place heavy objects on the armrests, leg rest or backrest as this may result in malfunction or injury.
- Do not use the massage chair when your body is wet.
- Do not operate the massage chair with wet hands.
- It is not recommended to use the massage for more than 15 minutes.
- Do not perform continuous massage on the same spot of your body for more than 5 minutes at a time as this may result in excessive stimulation and may have adverse effects.
- Do not insert your hand or foot along the paths of the massage rollers during use as this may cause injury.
- Stop operation immediately if you experience any discomfort.
- This product is not intended for self-treatment of conditions that should be managed by a qualified health care provider.
- People on medication or with medical conditions, please consult your doctor before use.
- Please do not use the product if you are not feeling well.
- Remove all scarves, neckties, necklaces and jewelry before using the massager.

● People with Medical Conditions

Consult your doctor before use if you:

- are under medical rest as ordered by a doctor.
- have spinal disorders, an abnormal spinal condition or have suffered a spinal injury.
- have back problems.
- have diabetes, osteoporosis or sensory impairment.
- have joint dysfunction.
- have a pacemaker or other electronic medical devices.
- may be pregnant.
- have phlebitis or thrombosis.
- have an increased risk for blood clots.
- had recent surgery.
- have surgical pins, screws, or anything mechanical implanted in your body.

Safety

● Instances When the massage chair Should Not Be Used

In the following events, please switch off the main power switch immediately and disconnect the power cord from the electrical outlet:

- If water is accidentally spilled onto the massage chair. This may result in electric shock or malfunction.
- If the fabric of the backrest is torn and the internal components are exposed.
- If pain or discomfort is felt during massage, stop operation immediately and consult your doctor.
- If you detect any malfunction or any other abnormal condition during operation.

● Assembly and Repair of the massage chair

- Do not disassemble the backrest cover of the massage chair. Touching the internal components may result in malfunction or electric shock.
- The massage chair must only be professionally serviced or repaired. Do not attempt to disassemble or repair the massage chair yourself.

● Things to Note About the Power Plug and Cord

- Check that the Alternating Current (AC) voltage corresponds with the specifications indicated for the massage chair.
- Do not connect or disconnect the power plug from the electrical outlet with wet hands. This may result in malfunction or electric shock.
- When disconnecting the power plug, pull it by holding the plug, not the cord.
- Although operation will be stopped automatically by the Auto-Timer function, always remember to switch off the main power switch after use.
- Do not place the power cord under the massage chair or any other heavy objects.
- Do not wind the power cord around the massage chair as this may damage the cord and result in a fire or electric shock.
- Do not operate the massage chair with a damaged cord or extension cord.
- Do not use the massage chair if the electrical outlet is loose.
- If the power cord is damaged, it should be replaced by a qualified technician.

Safety

● Grounding Instructions

This product must be grounded. If it should malfunction or breakdown, grounding provides a path of least resistance for electric current to reduce the risk of electric shock. This product is equipped with a cord having an equipment-grounding conductor and a grounding plug. The plug must be plugged into an appropriate outlet that is properly installed and grounded in accordance with all local codes and ordinances.

DANGER - Improper connection of the equipment-grounding conductor can result in a risk of electric shock. Check with a qualified electrician or serviceman if you are in doubt as to whether the product is properly grounded. Do not modify the plug provided with the product - if it will not fit the outlet, have a proper outlet installed by a qualified electrician.

This product is for use on a nominal 100-240V~ circuit and has a grounding plug that looks like the plug illustrated in sketch A as following illustration. Make sure that the product is connected to an outlet having the same configuration as the plug. No adapter should be used with this product.

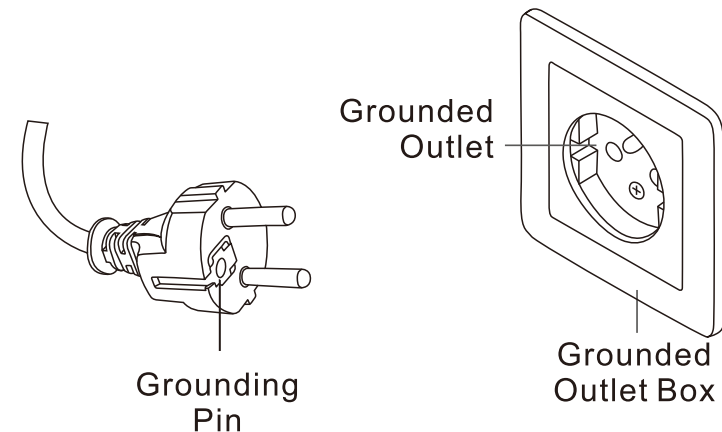

Outer Structure

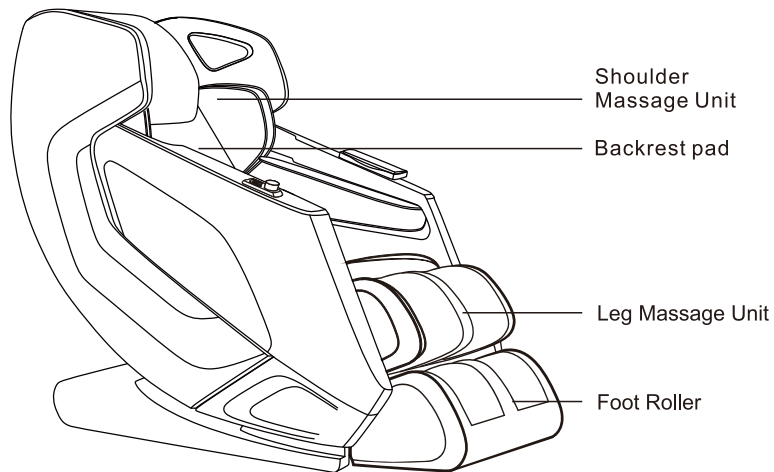
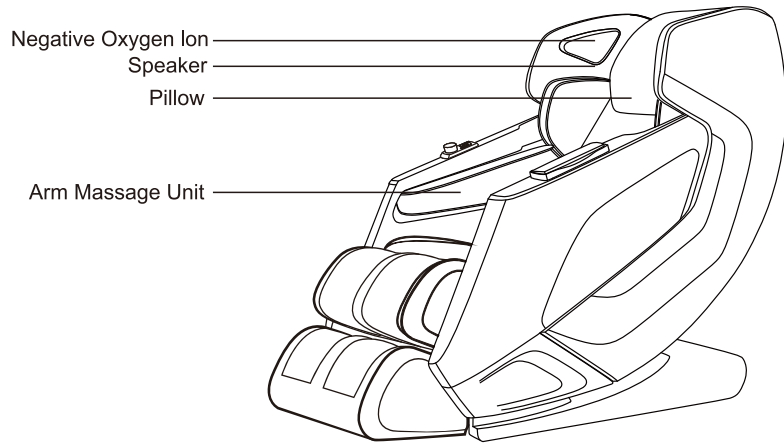

Installation and moving

Move the Chair

- Please turn off the main power and unplug the power from the electrical outlet.
- Tilt the chair backward as shown in the picture below and wheel it to the desired location.
- Please cover the floor with mat when move the massage chair in case of any damage of floor will be made.

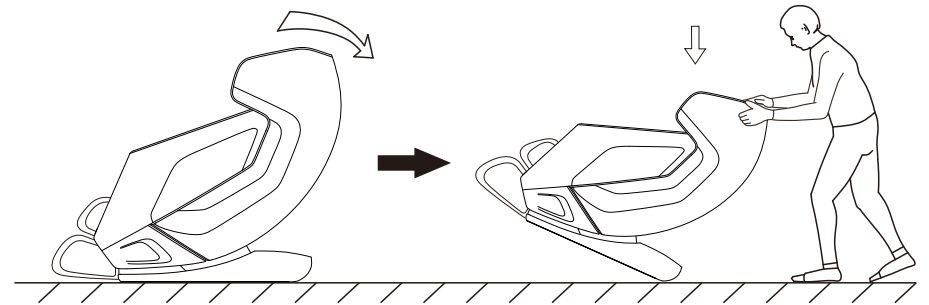

Place the Chair

Please make sure that there is an allowance of more than 5cm behind the massage chair, and more than 35cm in front of the massage chair to allow the backrest to recline without obstruction during operation.

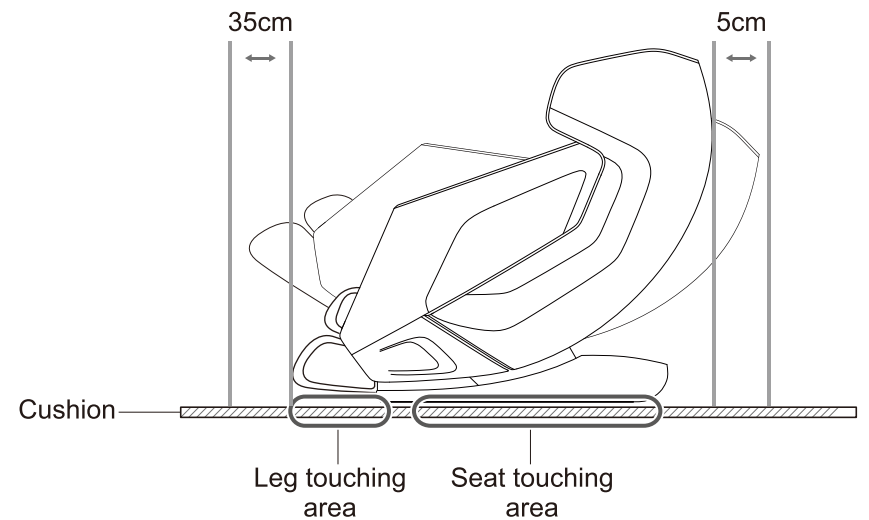

Installation and moving

Install Backrest Pad and Pillow Pad

- Attach the upper backrest pad to backrest with zipper.
- Attach the pillow pad to backrest with velcro.



- Attach the left side of backrest pad to backrest with zipper, same as the other side.

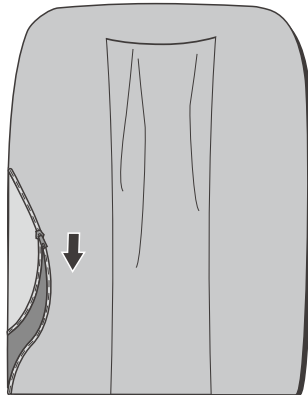

Installation and moving

Install Legrest

- As shown in the figure, insert the air tube ① and DC cable ② into the slots.

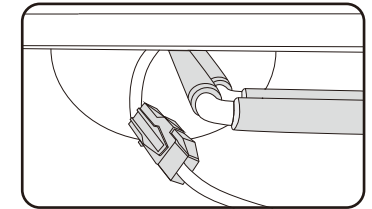
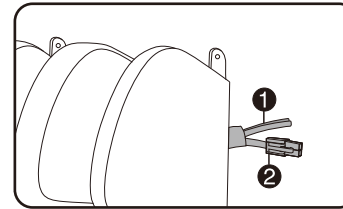

- As shown in the figure, install the slots ③ of legrest into fixed part ④.

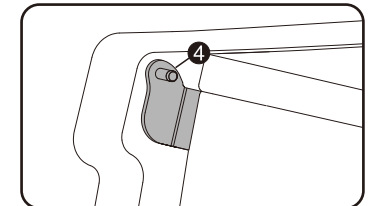
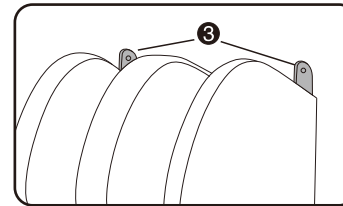

- As shown in the figure, insert the lock buckle ⑤ into each side, installation finished.

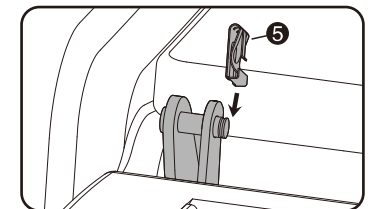
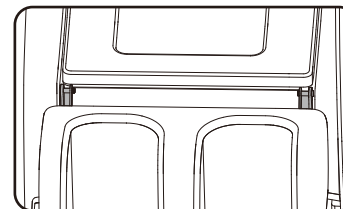

Installation and moving

Remote Controller Connection

- Connect the cable of remote controller with the cable under seat.

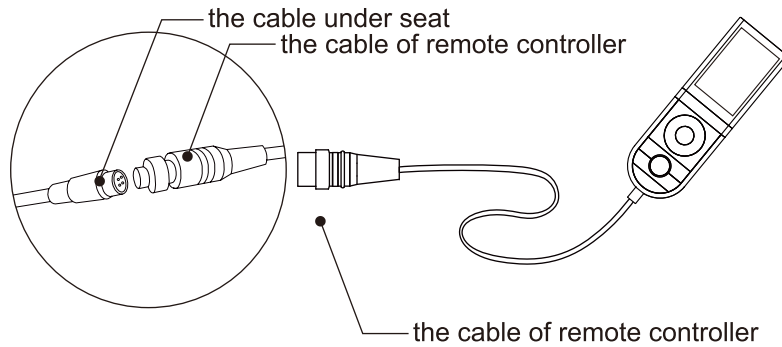

Connect power

- Plug the power cord into power inlet, turn on the power switch.

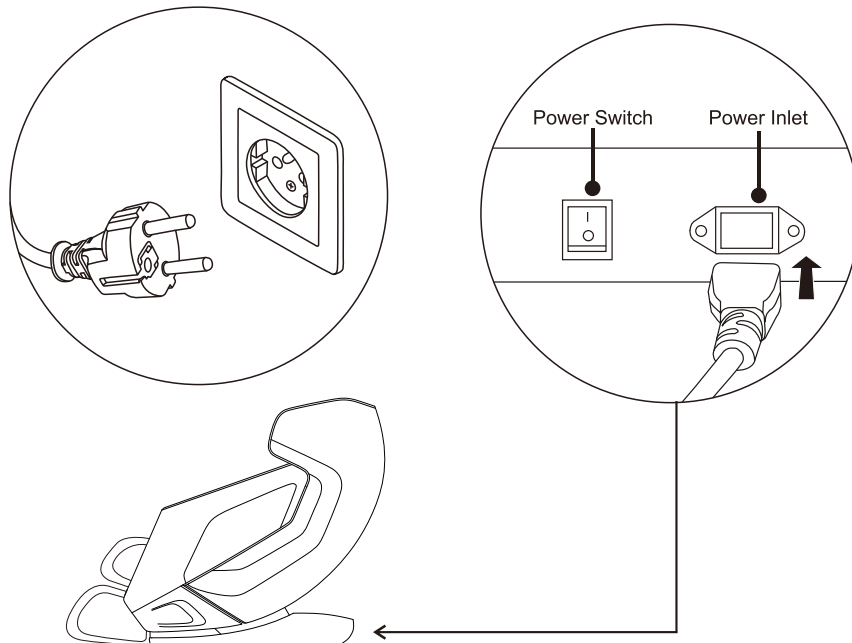

Instructions On Use

Functions of Controller

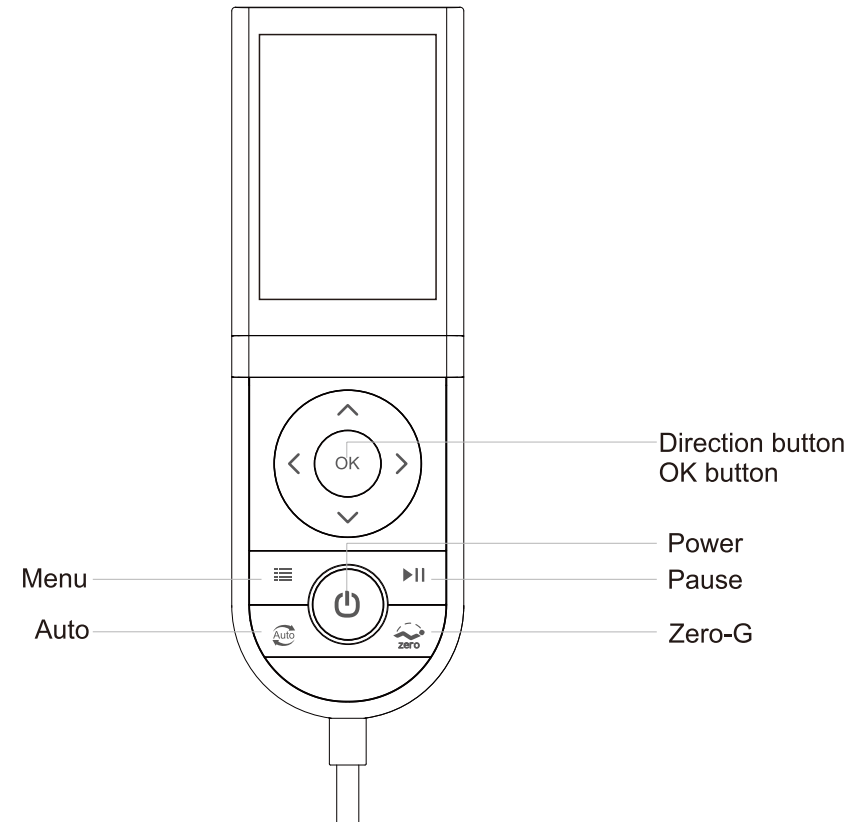

⚠ Caution

- Do not sit, step or place heavy objects on the controller.
- Do not drop the controller. It is recommended that the controller unit be placed in the controller side pocket when not in use.
- Do not exert excessive force on the controller.
- Do not handle the controller with wet hands.
- Do not operate the controller by using sharp-edged or hard objects. It may result in damage.

Instructions On Use

Functions of Controller

Power:

When plugged on, press power button to start the massage chair and press again to shut off.

Pause:

Press pause button to stop all massage function at the same time, and press stop button again to restart work again.

Menu:

Press menu button to check the function list.

Direction button and OK button:



Press up, down, left and right to choose corresponding functions and confirm with OK button to start it. In shoulder testing and auto mode, press up or down can control movement location of part and fixed point.

Zero-G:

Press zero-g button to shut or shift gravity level .







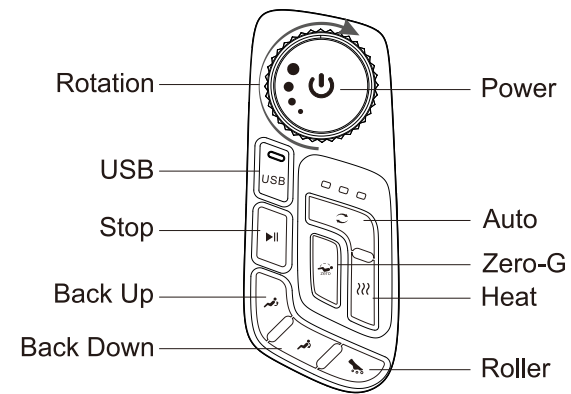

Auto:

Press this button to switch between multiple automatic program functions. The specific display is subject to the actual product.

Instructions On Use

Shortcut Buttons



Function	Button	Instruction
Power		ON/OFF
Rotation		Rotate clockwise to increase stage, and counterclockwise to decrease stages. The stage are divided into 1-6 stage.
Stop		Press this button to pause the massage function. Press again to resume the original massage function.
Auto		Press this button to switch between multiple automatic program functions. The specific display is subject to the actual product.
Heat		Press this button to turn ON/OFF the heating function.
Zero-G		Press this button to turn off or switch the zero gravity of stage 1 / 2 / 3.
Back Up / Back Down		Press the Back Up/Down button to adjust the backrest angle.
Roller		Press the button to activate Roller, Press again to stop this function.

Panel Icon Instructions

Auto Mode

Press menu button and choose auto mode to select auto modes. Press up, down, left and right to choose and press OK to confirm.

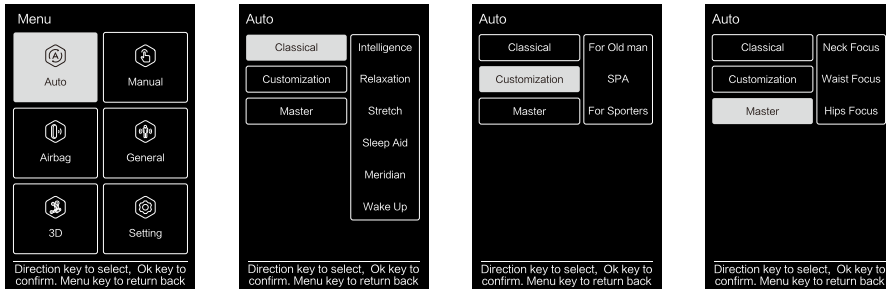

Manual Mode

Press menu button to choose manual mode and press up, down, left and right to choose corresponding function and press OK to confirm.

Technique: you can select different massage technique.

Massage area: you can select the massage area by your own.

Width & Intensity: you can customize the roller width and speed.

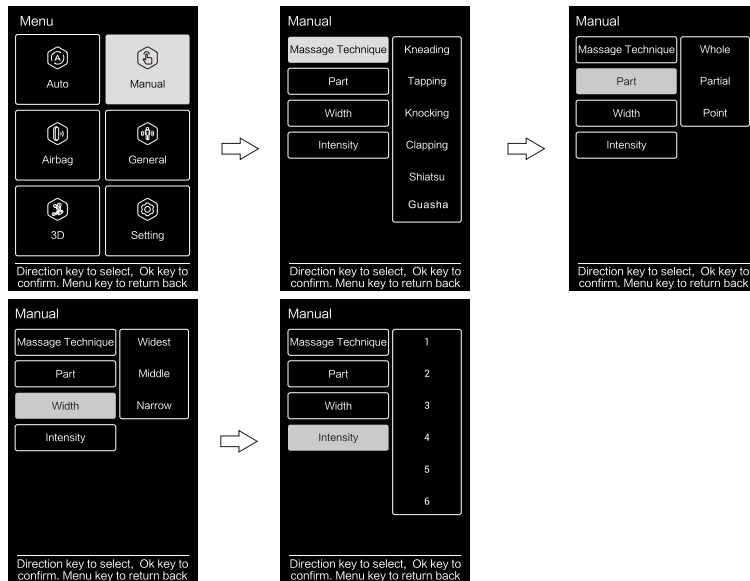

Panel Icon Instructions

Airbag

Press menu and choose airbag, choose the function through direction.

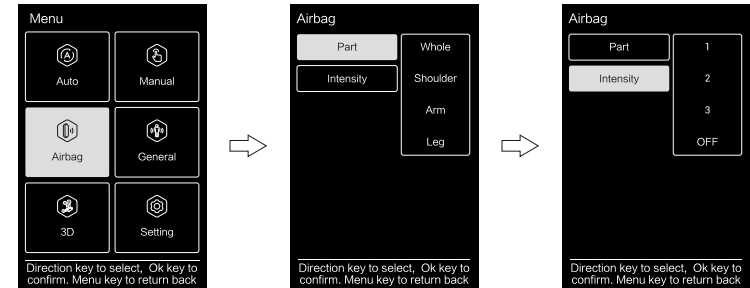

Part: airbags are available for whole body, shoulders, legs and arms.
Intensity : it can be chosen from level 1-3. If it is shut down, the pressure should be re-chosen again to adjust the strength.

General

Press menu, choose general function to select the Zero-G position, roller speed, and heating on/off. Press direction key to choose corresponding function and press OK button to confirm.

Angle adjustment: You can choose the backrest up/down and the footrest up/down to adjust the massage angle. After selecting, long-press the "OK" key to adjust the angle, and release it to lock the angle you like.

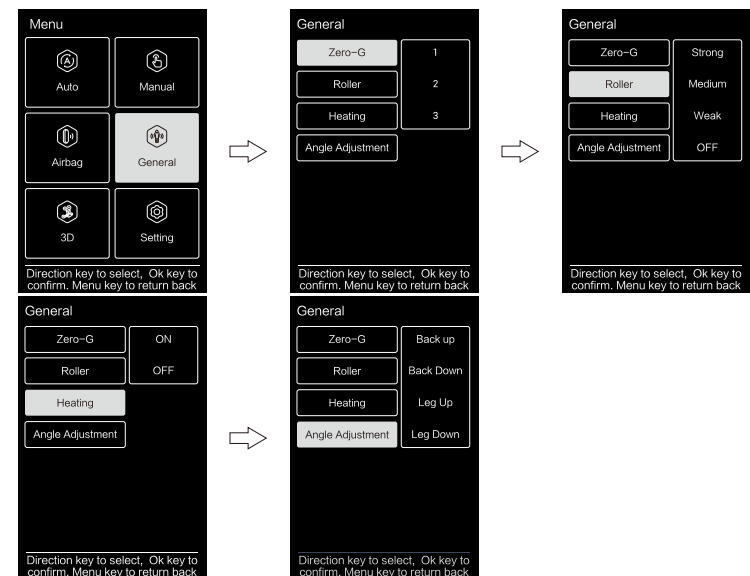

Panel Icon Instructions

3D

Press menu and choose 3D, choose the function through direction.

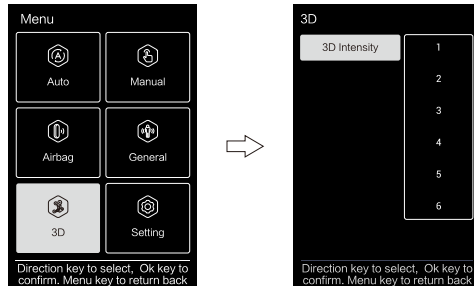

3D intensity: 1-6 levels to adjust 3D intensity.

Setting

Press menu, and choose setting function. Press direction key to choose corresponding function, and press OK key to use.

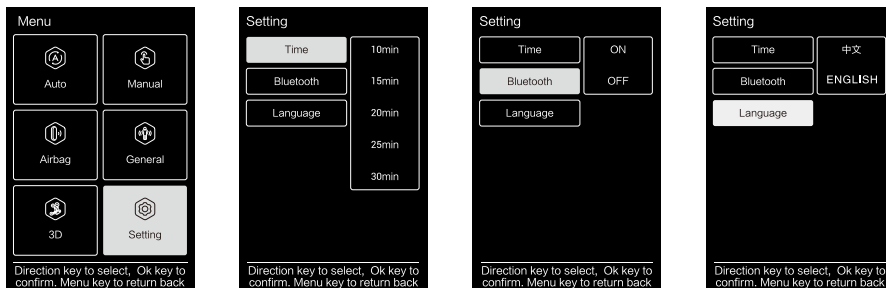

Time: Set the working time, 10/15/20/25/30 minutes.

Bluetooth: Turn on or off the Bluetooth function.

Language: Select the remote language.

Cleaning and Maintenance

Maintenance advice

Please follow the below steps to clean leather and plastic parts

- Please ensure the main switch is turn off and the power plug is unplugged from the electrical outlet.
- Dip a soft, dry cloth in water or warm water containing 3% to 5% neutral detergent and wring it thoroughly.
- Clean the leather and plastic parts.
- Then wipe with dry soft cloth.
- Let it dry naturally.

Warning

- Do not use alcohol, thinner, gasoline and other chemicals for cleaning.
- Do not dry the surface with a blower.
- Do not iron the fabric.
- During maintenance, always unplug the power plug. Do not unplug it by wet hands.
- Please use a dust cover to avoid dust if you won't use the chair for a long time.
- As fabric's color may be dyed on the leather, be careful when using denim and colored cloth to wipe the product.
- Wipe the product with the melamine foam dipped in mild detergent, if the dirt is hard to remove.
- Do not let the leather touch plastic in case of the color fading.
- Water temperature should not exceed 40 degrees.

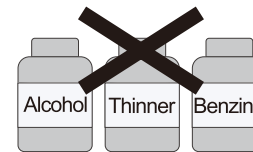

Please do not use



Water temperature should not exceed 40 degrees



Do not iron

Troubleshooting

Issues	Reasons	Methods
The movement stops on top.	After massage, for the sake of users health, the movement will move to top and stop there based on auto timing.	No measures required.
Sounds during work.	Normal sounds emitted during kneading or patting. Sound caused by friction between massage head and texture. Sound caused by up-and-down movement. Sound from deflation of airbag. Sound from the raising or lowering of massage parts.	No measures required, it is normal sound from internal operation.
Cannot turn on or control panel cannot work.	The power plug is not well inserted or loosen.	Plug in properly.
	The power on bottom does not switch on.	Switch to ON location.
	The fuse is broken.	Contact after-sales service to change a new fuse.
Massage rollers stop working.	Too much stress for massage rollers that they stop working.	Reduce the pressure towards rollers or restart.
Backrest or leg massaging cannot raise or lower.	Too much stress for back or leg.	Reduce press to back or leg.
Power cord or power sock emits heat abnormally.	Abnormal phenomenon and power should be plug off at once.	Stop using immediately and contact after-sales service.

It is forbidden to detach and repair the chair at will and if there are product damages or personal damages caused by, we will not take the responsibility.

If there is any quality related issue regarding the massage chair, please feel free to contact us at the email printed on the user manual.

Specifications

Model	R6S02
Rated Voltage	100-240V~
Rated Frequency	50-60Hz
Rated Power	170W
Upright position-Approximately	1400×753×1120mm
Reclined position-Appr	1560×753×965mm